



dingz

Présentation

Infiniment intelligent & extrêmement simple



Optimisation de l'énergie

Nous développons des produits visant à optimiser l'utilisation de l'énergie afin de participer à la protection de l'environnement et l'écologie.



Bilinguisme & *Swiss Design*

100% de nos employés sont bilingues et notre encrage dans le canton de Fribourg et en Suisse reflète nos valeurs.



Qualité

Nous nous attelons à nous différencier non seulement par la versatilité de nos produits mais surtout par leur très haute qualité



Confort et automatisation

Nous apportons à nos clients une valeur ajoutée en termes de confort d'utilisation mais aussi en automatisant les tâches ce qui améliore le quotidien de nos clients.



70 appartements - Saint-Gall



41 appartements - Huttlerpark



6 villas jumelées – Courroux



Fonctionnalités de base

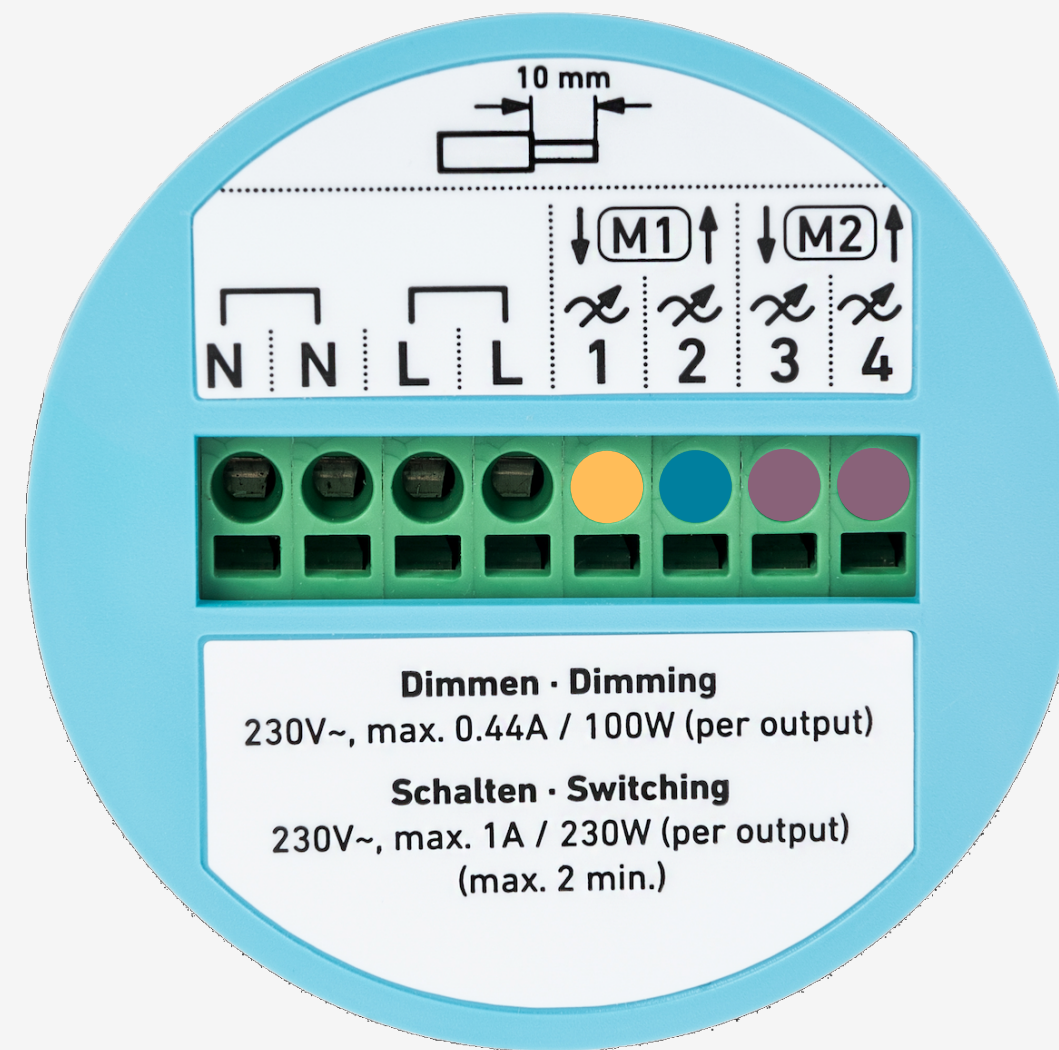

- 1  Lumière - dimmer
- 2  thermostat
- M2  store & lamelles
-  détecteur mouvement
-  ventilation
-  prise commandée

Le dingz comporte 4 poussoirs (dimmers) ou 2 stores.
Les appareils sont directement fonctionnels sans configuration

Capteur de présence

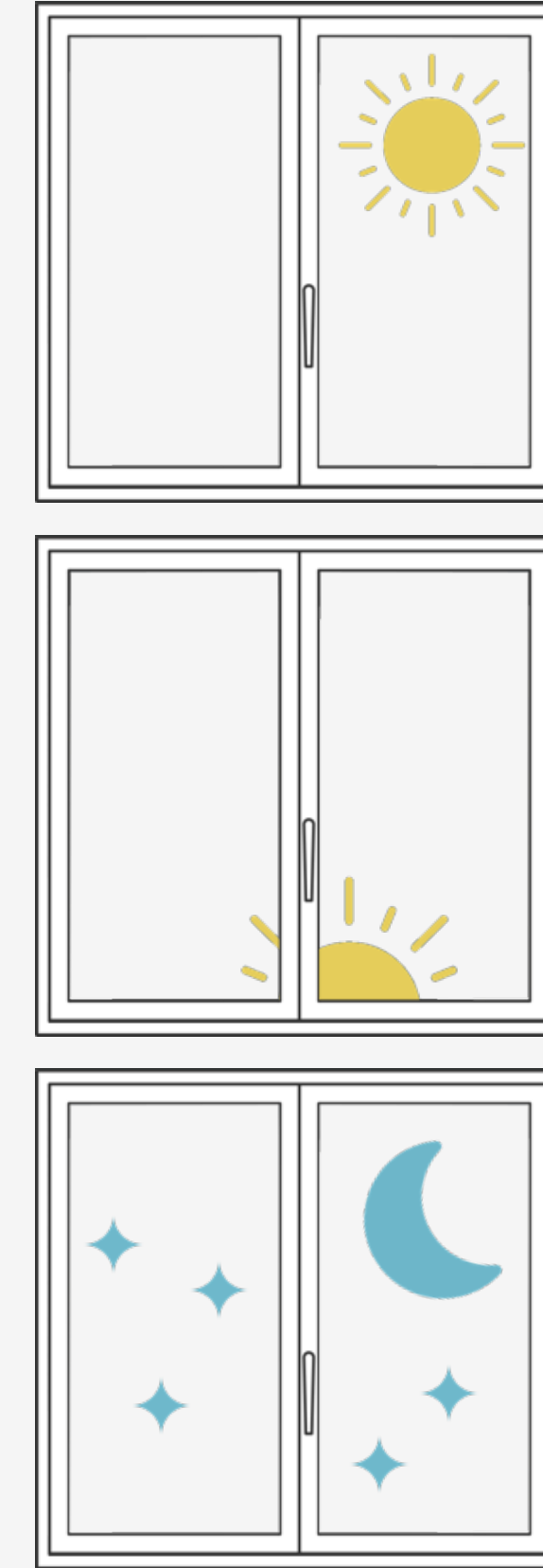
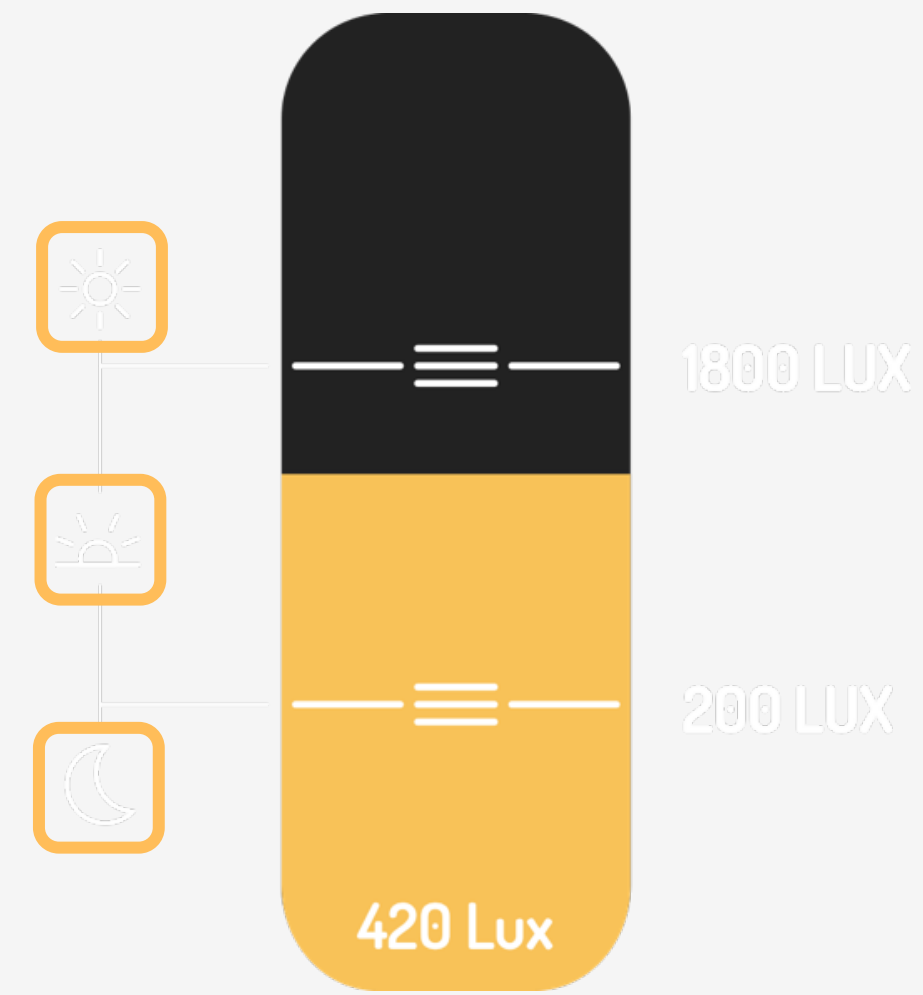
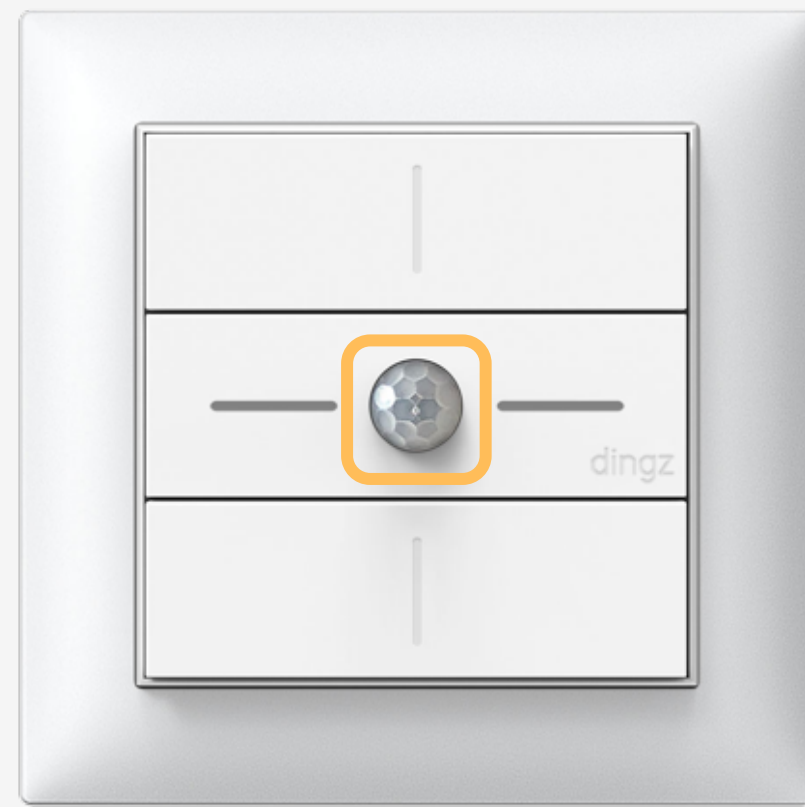

Allumage de la lumière en fonction de la luminosité extérieure via le capteur de présence

Configuration locale



Créez votre propre configuration locale via l'app via l'accès point dingz.
Les sorties sont indépendantes des poussoirs et sont donc modulables

Configuration locale

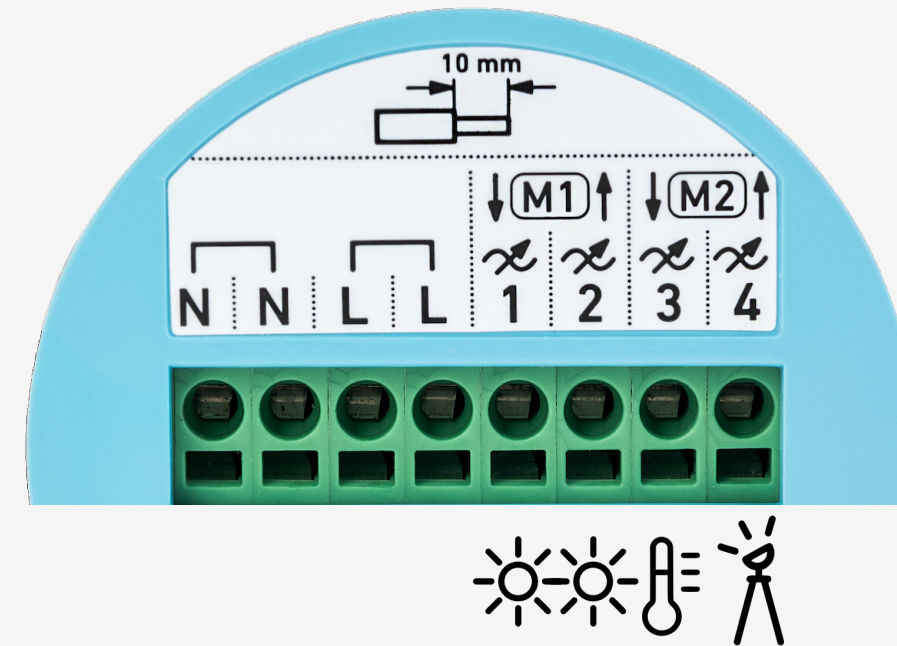

Exemple lumières

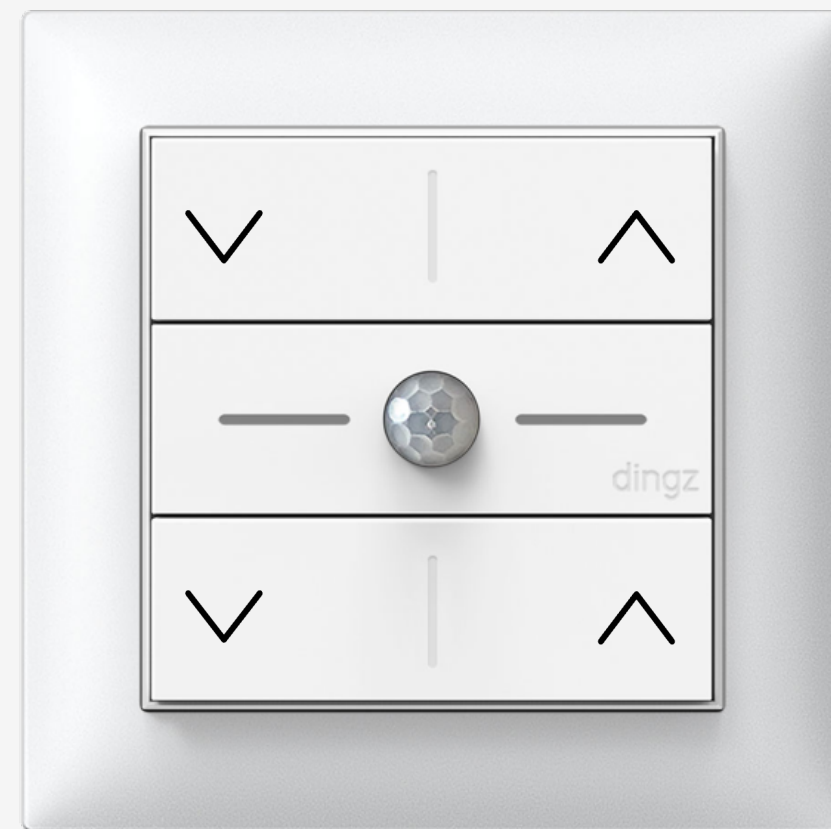
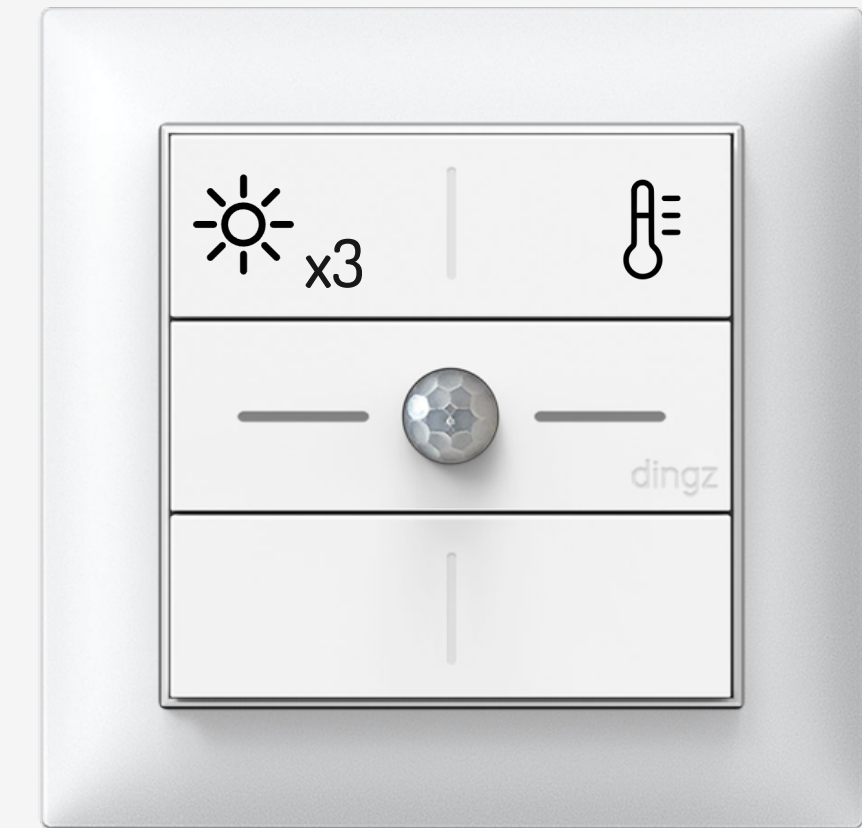

Sans configuration de touches

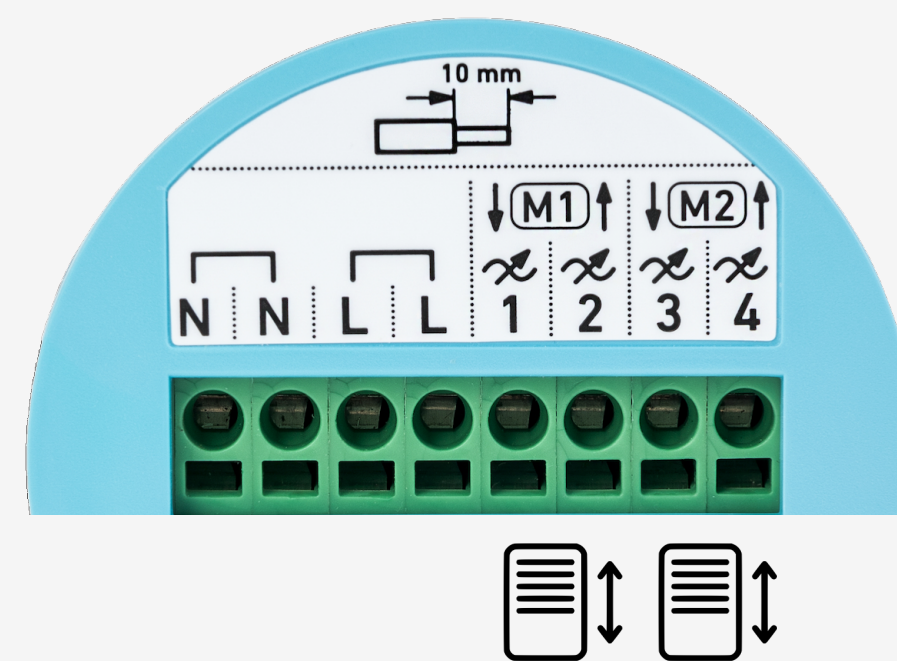

Exemple stores

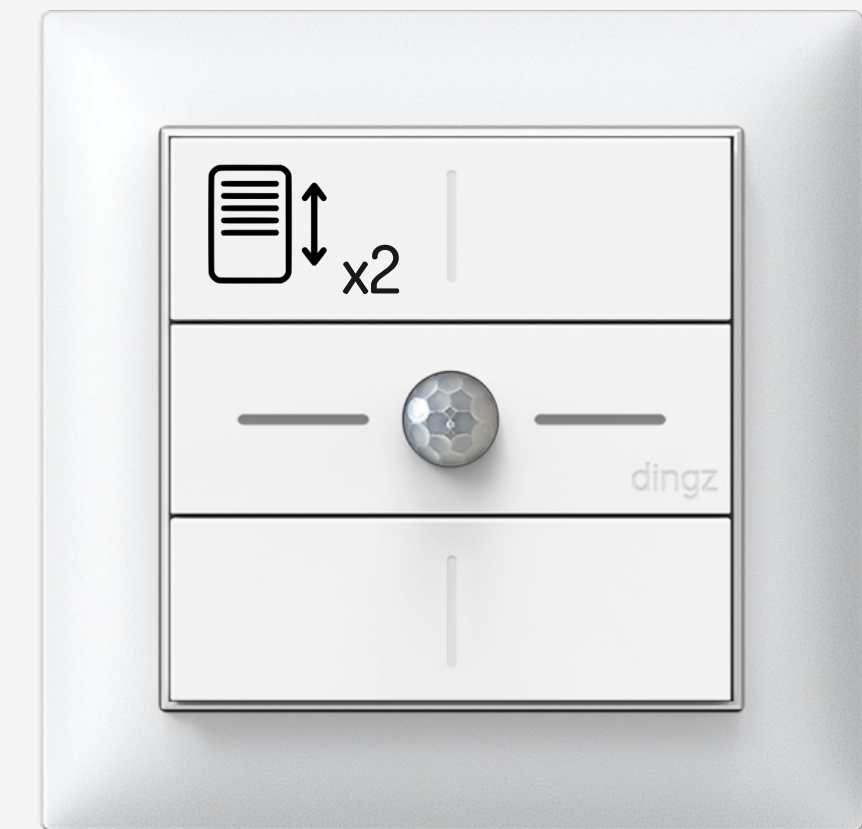

Avec configuration de touches

Les touches sont modulables par rapport aux sorties

Configuration via Wifi



Lampes et scènes Hue, musique via Sonos et fonctions de dingz à dingz via l'application.

Compatibilité avec les interfaces vocales



Connectez des fonctions comme le contrôle vocal et les scènes de
Google Home / Alexa / Homekit avec Siri

Systemes compatibles



Q3/4 2022



Q3/4 2022



Via MyStrom



dingz for all your things



Regroupe 4 fonctions en un seul appareil
Une installation dingz n'est pas beaucoup plus onéreuse que le classique interrupteur



Temps d'intégration aussi aisé qu'un standard
Configuration simple avec guide pas à pas



Investissement long terme dû à la technologie évolutive sans changement du hardware



Compatibilité avec interfaces ouvertes



Disponibilité garantie car toujours opérationnel, même en cas de panne réseau



Couleurs



dingz est disponible dans de nombreuses couleurs et les interrupteurs peuvent être gravés pour une multitude d'applications.

Cadres



Compatible avec les cadres muraux Suisse des principaux fabricants (Feller, Hager et ABB).



Commander dingz



Fonctionnalités à venir

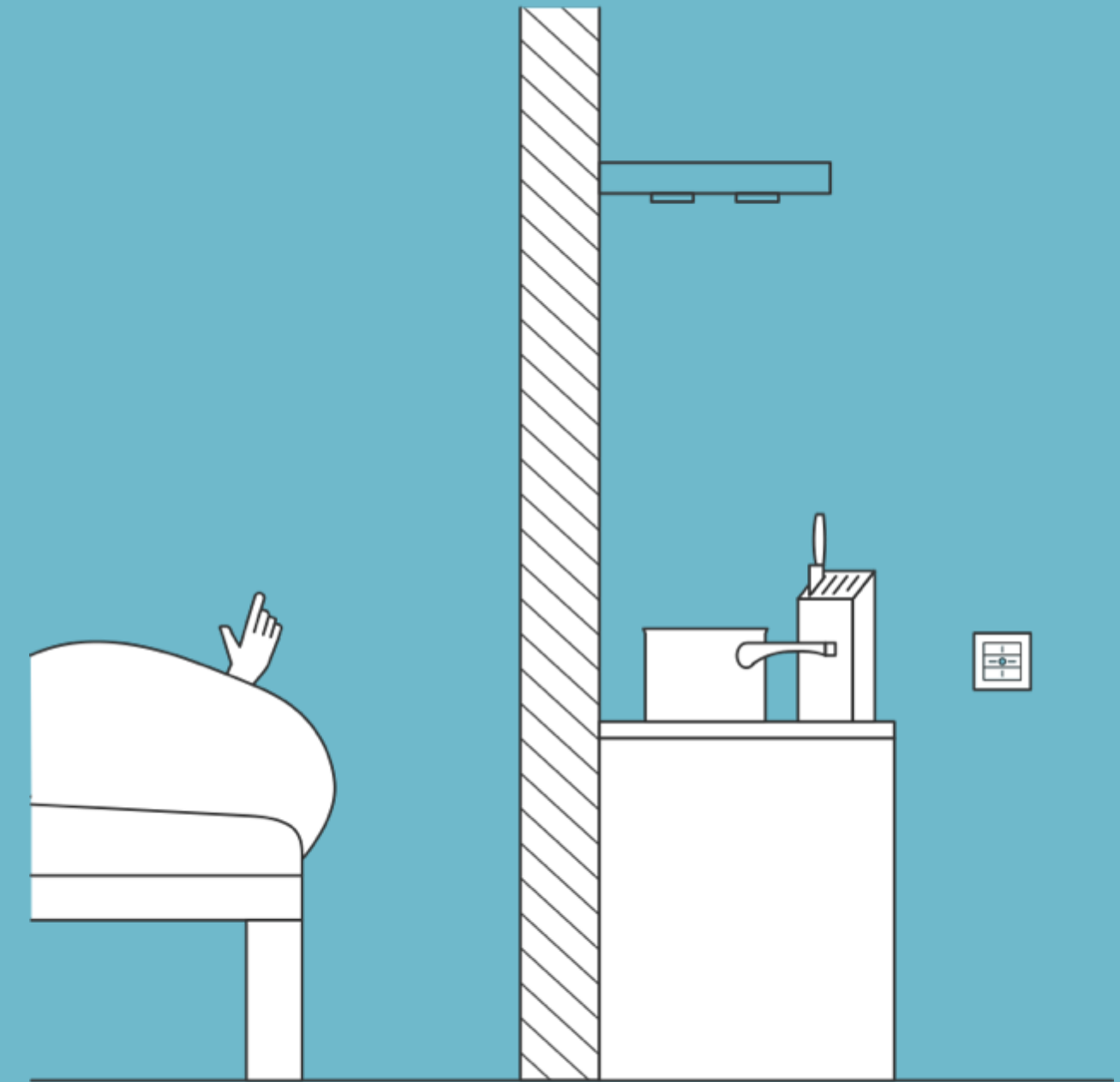
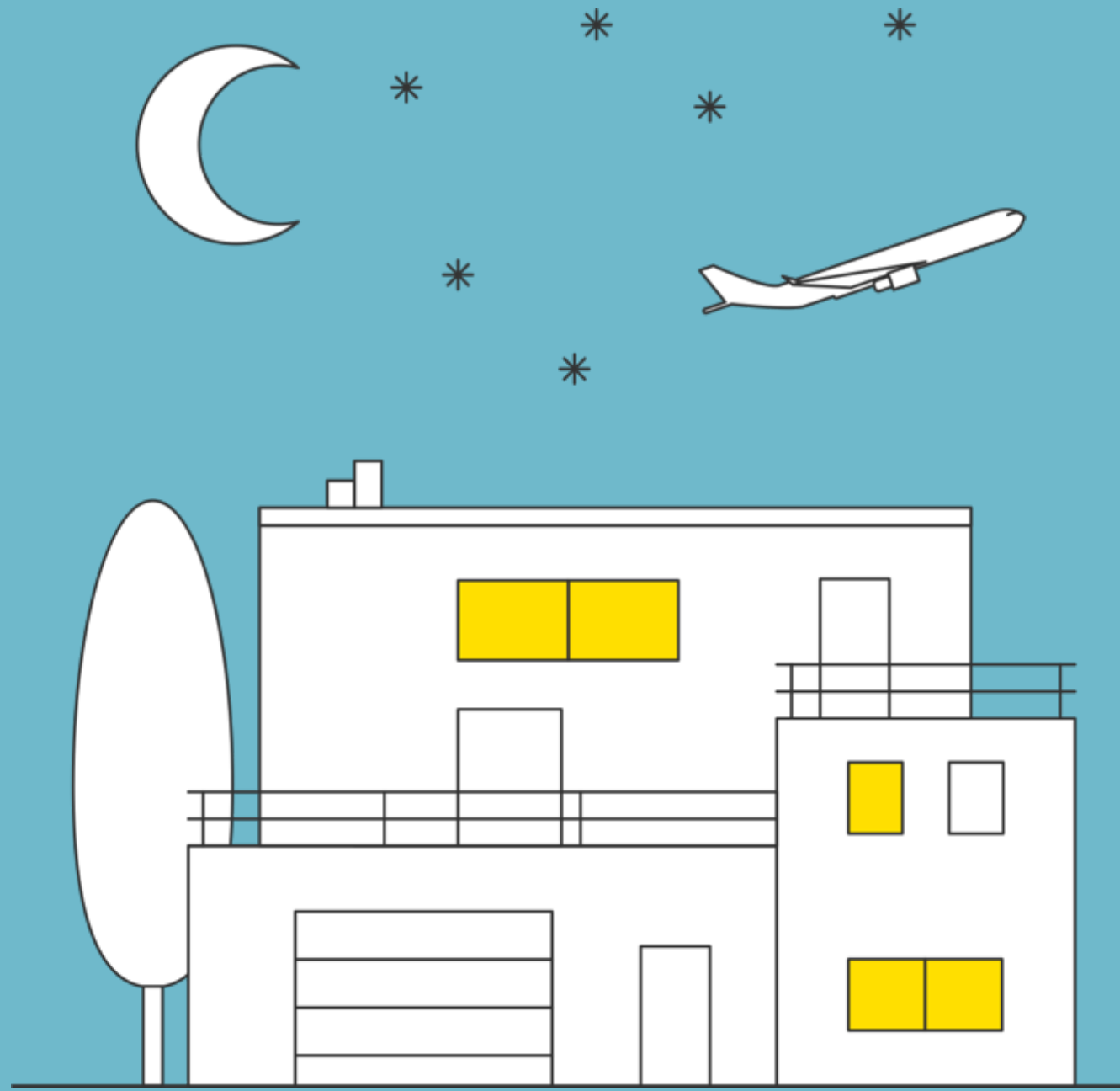

Accès à distance via cloud / Simulation de présence / Mode sécurité / Fonction
d'ange gardien / station météo



Economie d'énergie

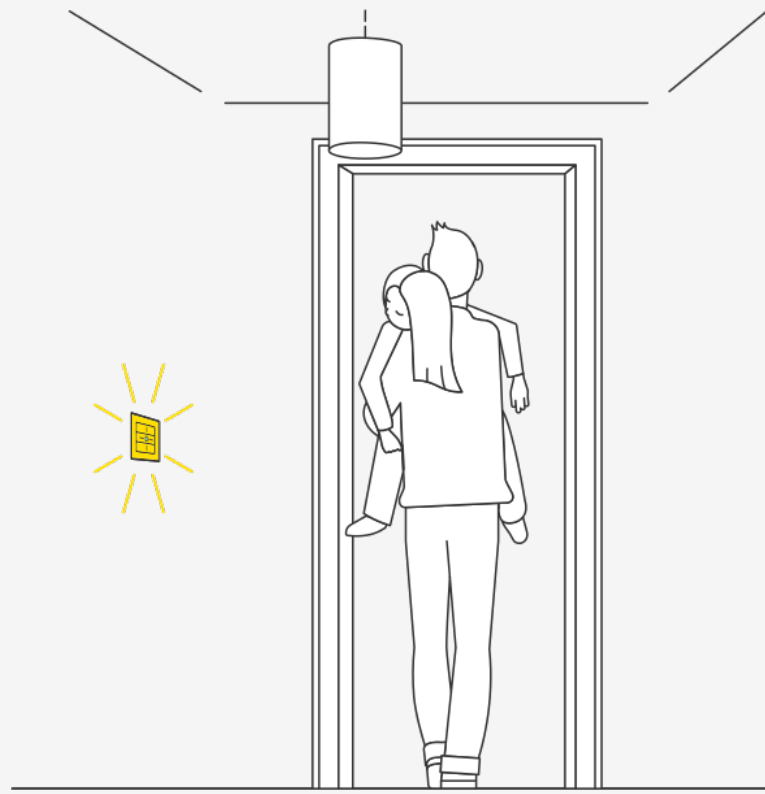

- PIR (detecteur de mouvement et mesure de luminosité)
- Dimming (10-50%)

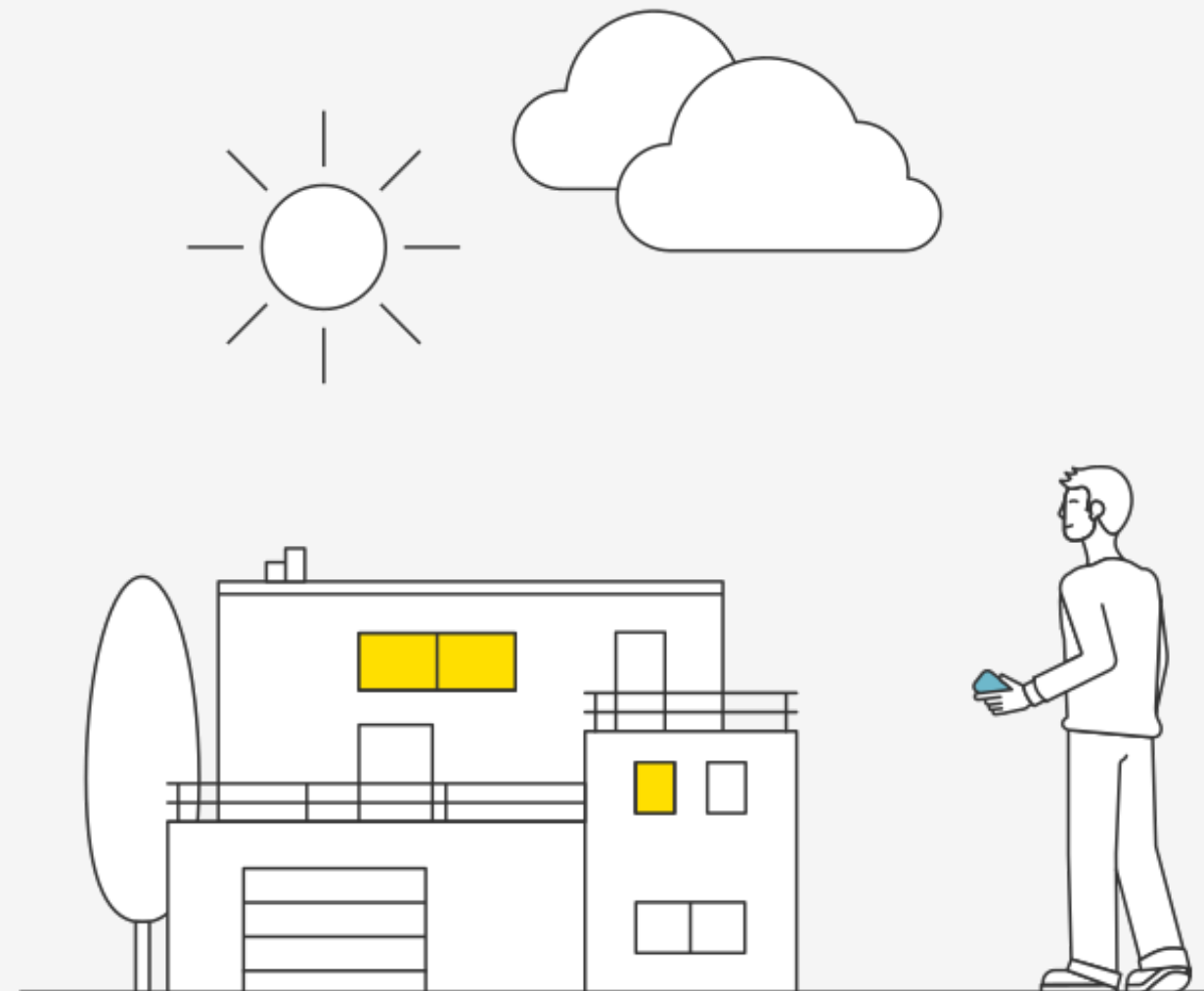

- Programmation et gestion à distance (chauffage)
- Station météo (gestion des stores et de la lumière proactif)
- Pas d'infrastructure locataire (serveur)

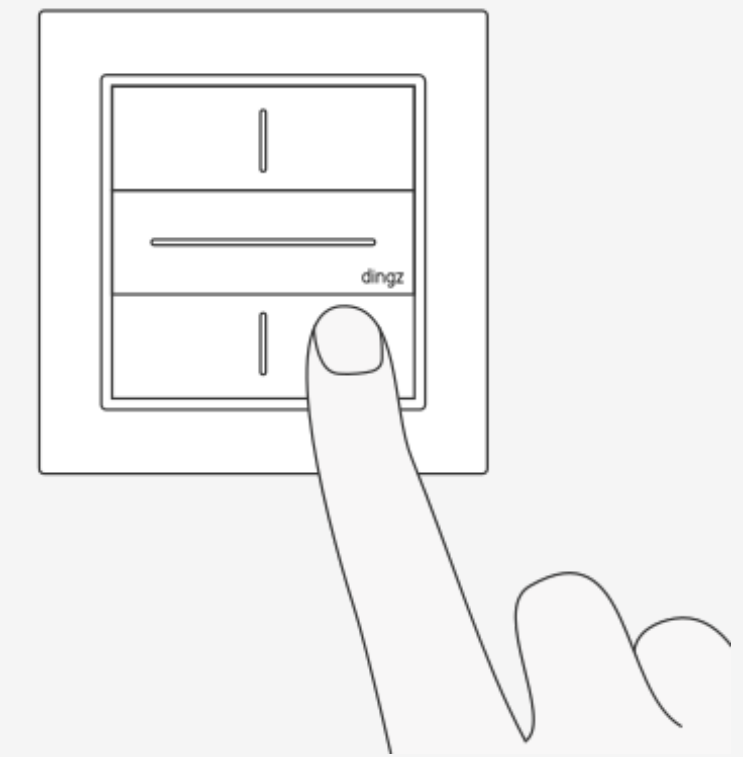

- Timer sur les touches pour extinction automatique
- Commande générale OFF
- Consommation dingz (0.9W)



Création de scénarios



Profitez pour gérer la luminosité de toutes vos lampes et créer des scènes personnalisées

Imaginez fermer les stores, tamiser la lumière et lancer la TV en un simple clic pour la soirée cinéma



Sauvegarde et réinitialisation















En cas de déménagement ou changement de locataire, le dingz peut être très rapidement réinitialisé

La configuration créée peut également être sauvegardée et ré-uploadée par la suite



Planification

Legende		
12x		Moteur
23x		Lampe - dimmer
4x		Led
4x		dingz avec PIR
11x		dingz standard
2x		PIR 180°
0x		PIR 360°
0x		Interrupteur std
3x		Prise commandée
4x		Ventilateur
0x		Thermostat
5x	RT	

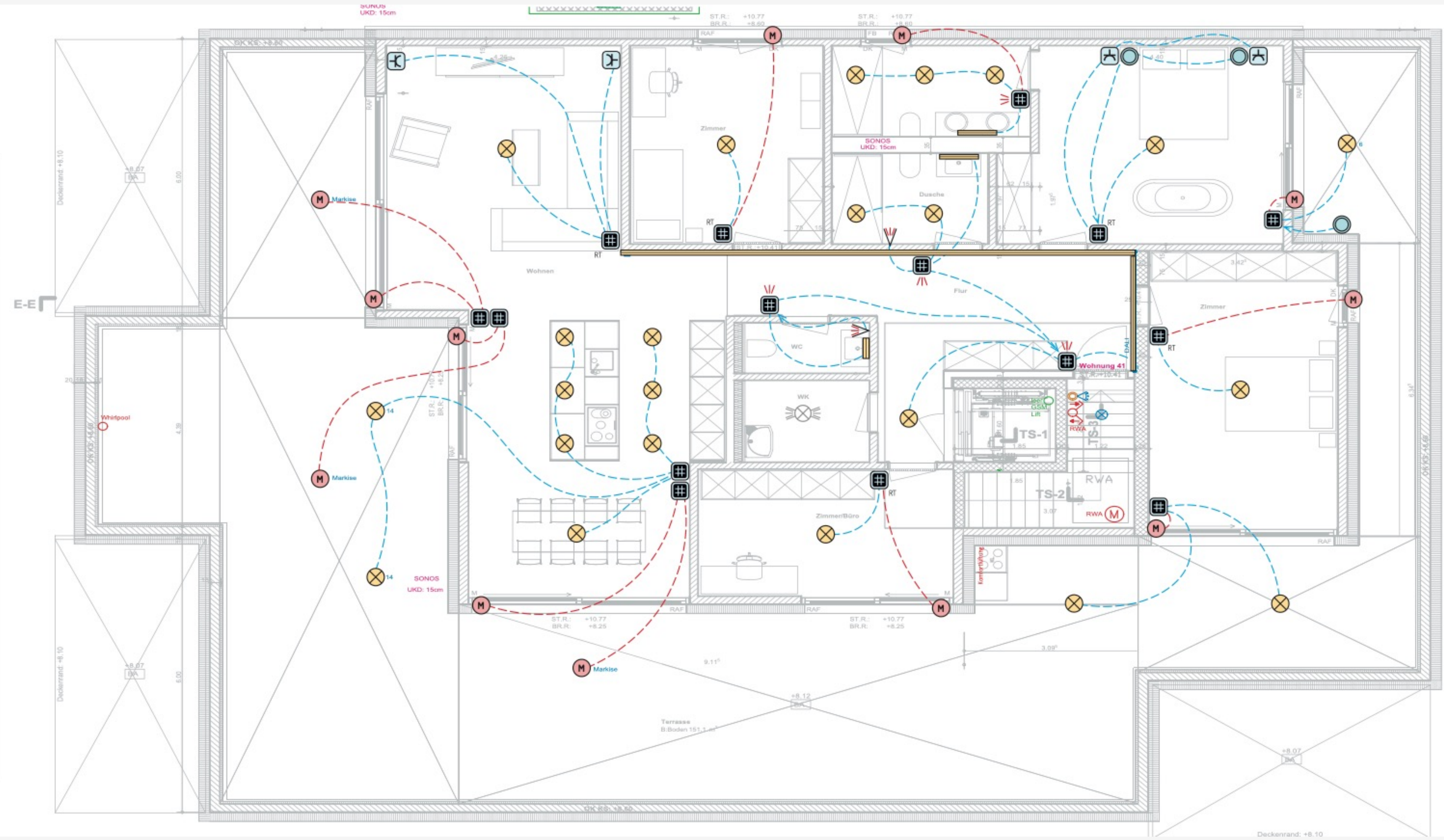

Exemple d'un plan d'étage

Quantitatif par logement



Quantité moyenne constaté par logement

Type appartement / logement	Qté dingz
1.5	2-3
2.5	5-7
3.5	8-10
4.5	10-12
5.5	12-14
6.5	17-19

